

WHAT'S IN THE BOX

Congratulations!

Thank you for choosing the Maxboost Durahold Magnetic Car Mount! This product is an adjustable magnetic holder for smartphones to provide a hands-free experience. Please take a moment to learn how to properly use your Durahold Mount.

Product Overview

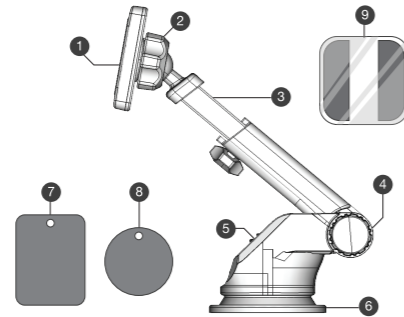

- | | |
|------------------------|--------------------------------|
| 1. Magnetic Mount Head | 6. Suction Cup |
| 2. Rotating Swivel | 7. 2x Rectangular Metal Plates |
| 3. Extendable Neck | 8. 1x Circular Metal Plate |
| 4. Adjustable Arm | 9. Mounting Square |
| 5. Locking Mechanism | |

BEFORE INSTALLATION

BEFORE INSTALLATION

1. Clean desired surface to ensure there is no debris



2. Remove protective layer from suction cup (if any)

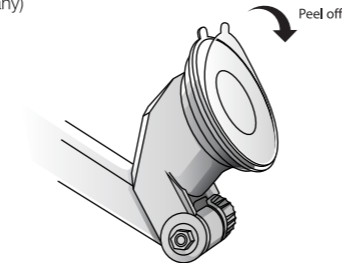

INSTALLATION METHOD

METHOD 1

Mounting Square (Recommended)

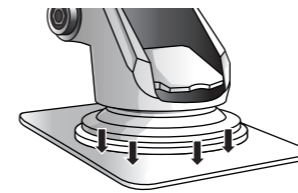

1. Attach the Mounting Square (PC) on the dashboard or flat surface.

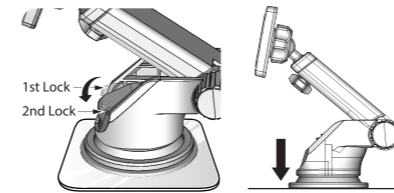

2. Install the car mount suction cup to the top of the Mounting Square.
3. Adjust the car mount arm to your liking.

INSTALLATION METHOD

METHOD 2

Place on Dashboard

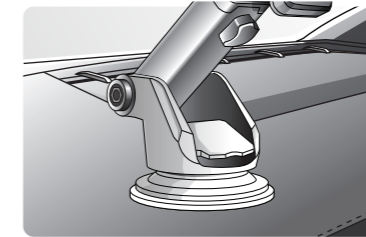

1. Place the suction cup onto the car dashboard.

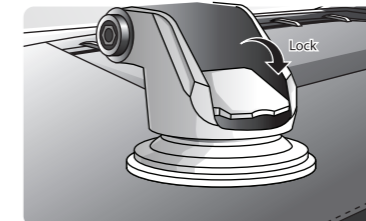

2. Lock the cup down using the locking switch located on the front of the mount.

INSTALLATION METHOD

METHOD 3

Place On Windshield



1. Place car mount on the cleaned area.
2. Hold down the mount with one hand and use the other to lock the mount into place.
3. Adjust the knob and arm to your liking.

INSTRUCTION

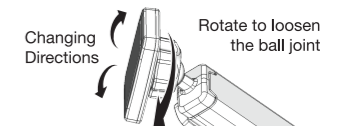

Rotate the circular neck dial to loosen the ball joint to swivel the device in almost any forward facing direction.

INSTRUCTIONS

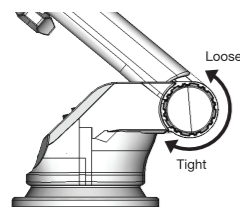

Turn the dial near the base to loosen or tighten the mount arm. This enables a forward or backward swivel.

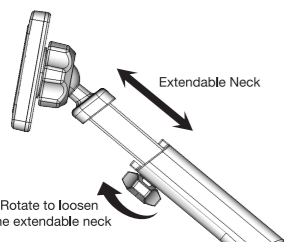

Adjust the dial here to elongate or shorten the neck of the mount to provide an easier reaching distance.

INSTRUCTIONS

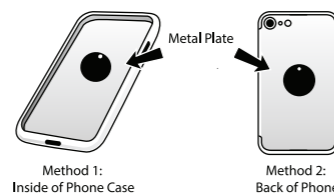

Securing Your Device

1. Choose either the circular or rectangular metal plate.
 2. Clean either the back of the phone or the inside of the casing.
 3. Remove the 3M sticker from the metal plate and secure it to the device/case.
- Note: If using a case you do not need to remove the 3M sticker (this way the metal plate can be reusable)

Note: Metal plate may interfere with wireless charging. Recommended to take case off and/or remove the plate before charging.

INSTRUCTIONS

Applying on an Uneven Surface

1. Use the included Mounting Square with attached 3M strip(s).
2. Completely clean the desired surface and attach the plate with adhesives.
3. Finally, attach the suction cup base to the Mounting Square.

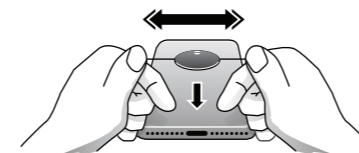

Removing the Metal Plate

1. Apply a few drops of rubbing alcohol around the metal plate.
2. Using a string in a back and forth motion slowly break the metal plate away from the surface.
3. Rub away any remaining adhesive residue with your finger.

Note 1: Do not use any sharp devices to remove the metal plate, any such use may damage the device.

Note 2: 3M stickers are not reusable. Additional 3M stickers can be purchased to reuse the metal plating

WARNINGS

Warnings

Read all the instructions before using this product. Failure to read and follow these safety instructions could result in potential hazards causing serious injury and/or property damage, for which damages you, (the purchaser), not Maxboost (the seller) is liable.

1. Do not modify, disassemble, open, drop, crush, puncture or shred the product.
2. This product is not intended for children and is not a toy. Keep out of reach of children.
3. Metal Plate can be harmful if swallowed.
4. Keep magnets away from high voltage devices.
5. This product is not intended for children and is not a toy. Keep away from children. Magnets can be damage sensitive objects such as pacemakers, computer hard-drives, televisions, computer monitors, credit cards, magnetic ID cards and other similar objects. Keep these objects at least 1 ft away from the magnetic car mount.
6. Ensure that all persons who use this product are familiar with the safety guidelines set forth in this manual.

FAQ

Q: My suction cup won't stay on the dashboard/mounting square, what can I do?
A: If dust or dirt gets stuck, restore the suction cup by rinsing with warm water and leaving it out to air dry.

Note: Prevent dust, particles, or fingerprint marks from getting on the suction cup to help retain its stickiness.

Q: My dashboard is made of leather or some other cloth material and the mount is not sticking.
A: Use the included Mounting Square with 3M stickers. This plate has a higher surface area and will stick better than just the mount itself.

Q: Will the weather effect how well my suction adheres?
A: Yes, we advise keeping the car mount away from the sun as much as possible.

Q: Can I use wireless charging with a metal plate equipped?
A: No, since the metal plate will interfere with the wireless signal. You will have to remove the case and the plate before wireless charging.

Q: How do I remove the car mount?
A: Unlock the locking mechanism and pull the tab on the suction cup until air is allowed through for easy release.

WARRANTY CARD

Date of Purchase

___ / ___ / ___

Need Help?

service@maxboostpower.com
www.maxboostpower.com